

**LIFTING AND  
TRANSPORT EQUIPMENT**

**2022**

**2023**

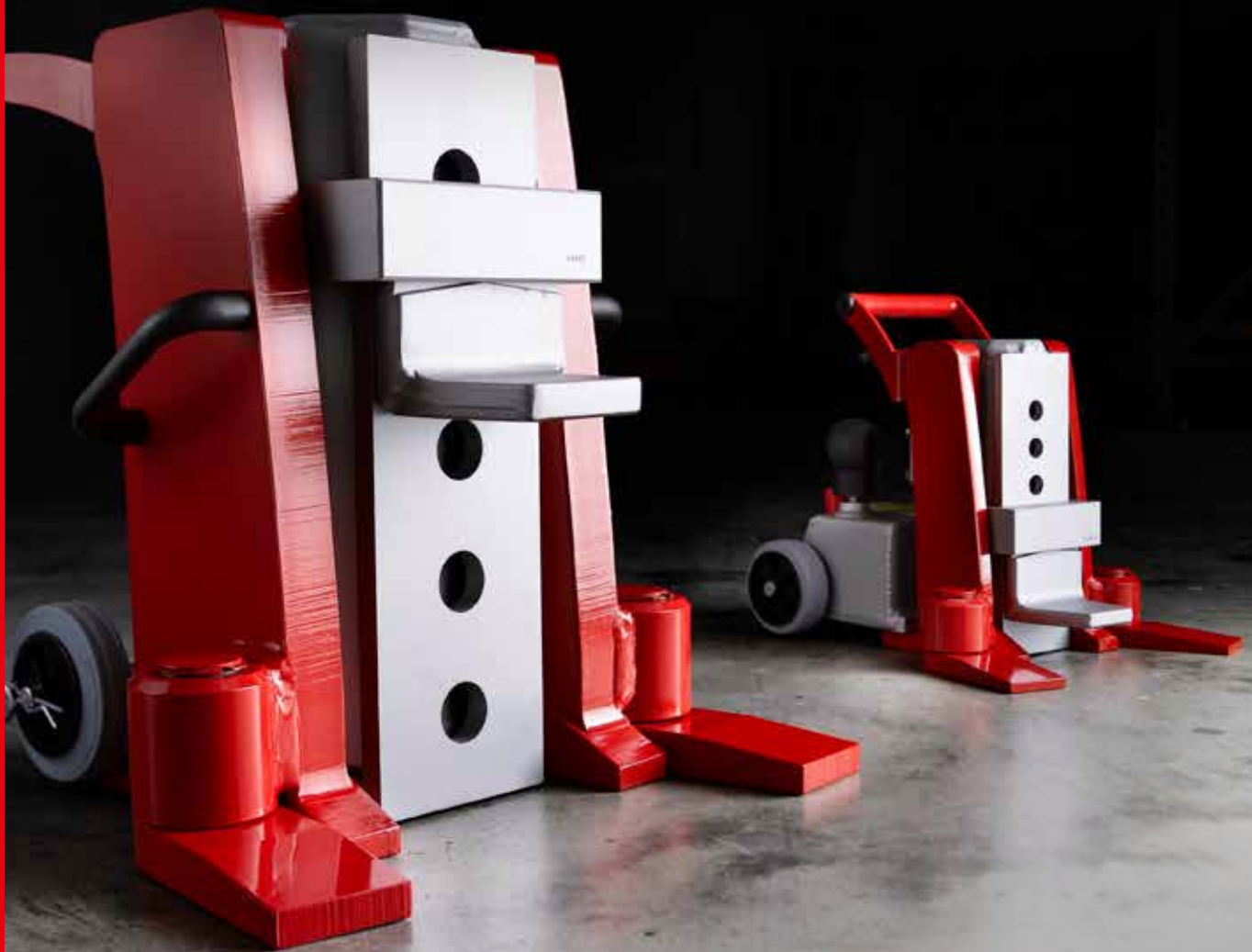

**JUNG**  
●●●  
**JUNG-HEBETECHNIK.DE**

**JUST MOVE SAFELY.**

**Our aim is** make lifting and moving heavy loads easier, safer and more ergonomic for the user.

**JUNG**



**WE MAKE  
A DIFFERENCE.  
TONS OF IT.**

#### QUALITY

You can always trust in the quality and durability of our products. To manufacture highest quality we use most modern machines and assure a continuously high standard by a certified quality management system.

State of the art CNC technology, advanced welding robots and a certified quality management system (DIN EN ISO 9001) assure a consistently high level of product quality. Each hydraulic jack is subjected to a pre-shipment function test and receives a test badge displaying the next recommended maintenance check date. Each self-powered trolley is also subjected to a pre-shipment function test.

Following products are ANSI/ASME (USA) tested: JH G-plus, JH G-plus EX, JHS, JKB, series K, series M.

#### PROCESSES & ENVIRONMENT

As an ISO 9001 certified company we continuously improve our processes by involving our customers, employees and suppliers.

**JUNG on the move.**

# SOME STATIONS.

In several stages, JUNG was expanded from a one-man operation to an international company. In the meantime JUNG has more than 50 employees. Many of them have been with the company for a long time, in some cases even completed their training at JUNG. Our employees have the goal of working together to achieve the best for our customers. Our ambition for 50 years is to make lifting and moving heavy loads easier, safer and more ergonomic for the user. According to our slogan: JUNG = Innovation, Karl-Heinz Jung and Thomas Würthele, together with the JUNG employees, have developed a large number of different devices to be able to offer the right product for every application.

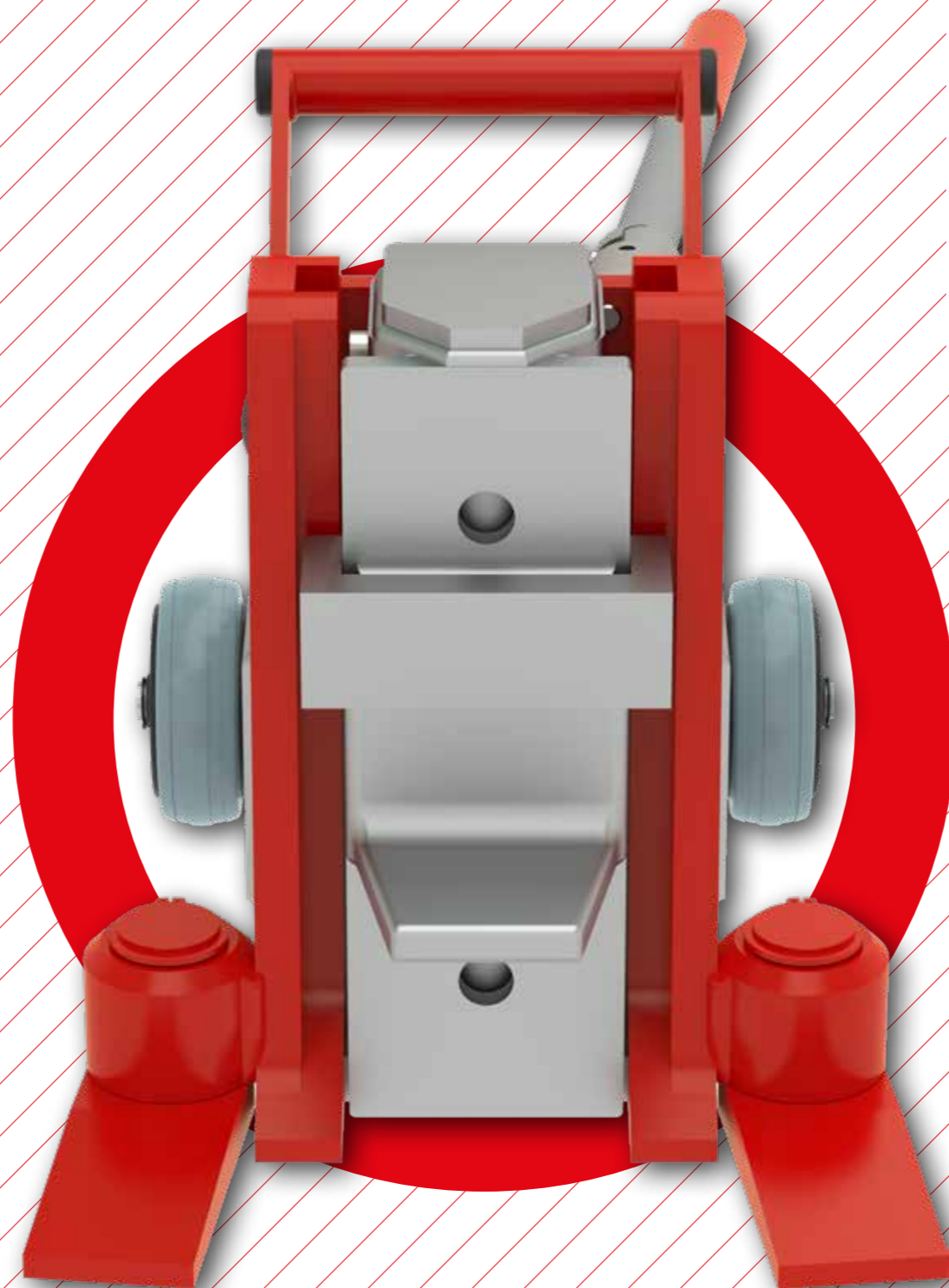

**1972**

### FOUNDING

Karl-Heinz Jung founds the company JUNG in Kernen near Stuttgart.



**1982**

### FIRST COMPANY BUILDING

The first own company building is built at the current location in Waiblingen.



**1993**

### OWN SALES

JUNG separates from the former exclusive distribution partner and builds up its own sales department.



**2001**

### NEW BUILDING

JUNG doubles the production area by building a new hall at the Waiblingen site.



**2002**

### TUGGER TRAIN

JUNG expands its product range and now also produces trailers for in-house logistics.



**2003**

### FOOT MASTER®

JUNG starts selling FOOT MASTER® leveling castors.



**2008**

### INDUSTRIAL HYDRAULICS

JUNG is again expanding its product range to include industrial hydraulics.



**2009**

### EXPANSION

JUNG further expands the production area by another hall at the Waiblingen site



**2014**

### NEW PRODUCT LINE

JUNG presents the first electric-powered trolley JLA-e 15/30 G.

**2022**

### 50 YEARS

The JUNG company celebrates its 50th anniversary.

**2020**



### SUPPORT TECHNOLOGY

Expansion of the product range with support technology and surface protection

**2017**



### GORR TRANSPORTECHNIK

JUNG acquires the company Gorr Transporttechnik GmbH in Eschwege.

**2017**



### LIFTING BAGS

JUNG starts the distribution of lifting bags.



# RESPONSIBILITY AWARENESS.



## CUSTOMER

The satisfaction of our customers is in the center of our efforts. Due to our creativity and our expertise, we realize individual customer requests.

## STAFF

The company's success is depending on our staff members. Therefore, we are continuously investing in training and development and support the experience and competence through long-term employment.

## SOCIAL COMMITMENT

We are a part of Waiblingen and are glad to support regional social and charitable organizations.

## ENVIRONMENT

We meet our ecological responsibilities in our daily work flow. We utilize our own solar power, obtain power from regenerative energy sources and have examined our ecological accountability under the Ecofit project.

# YOUR ADVANTAGES FROM OUR SERVICES:

## MADE IN GERMANY

We have 50 years of experience in the development and manufacture of rigging equipment. Our lifting and transport equipment has proven itself thousands of times as essential tools in all areas in which the movement of heavy loads is required.



## REPAIR & MAINTENANCE SERVICE

Even after many years of usage, our products are still ready for use. To achieve this we provide maintenance and repair service, as well as replacement parts.

## AVAILABILITY

Almost all standard product lines are in stock 365 days a year. Orders are usually ready for dispatch within 24 hours.

## WARRANTY

We provide a 5 year warranty on all jacks and transport trolleys when products are used as directed – except for JLA-e, where we provide a 1 year warranty or 1000 operating hours.



# LIST OF CONTENT

Jacks for loads up to 30 metric tons – series JH-G plus	15
Jack sets for loads up to 20 metric tons – series JHS	18
Hydraulic pressure blocks JD	20
Electrical pumps JPE	22
Hand pump JP and air hydraulic pump JPL	23
Useful accessories for jacks and hydraulic hoses JS	24
Trolley information and overview	25
Transport trolleys for loads up to 24 metric tons – series K	28
Transport trolleys for loads up to 28 metric tons – series K professional	30
Revolving transport trolleys for loads up to 28 metric tons – series JKB	34
Multi-purpose trolley for loads up to 15 metric tons – series M	38
Transport trolleys for loads up to 48 metric tons – series S	40
Tandem transport trolleys for loads up to 14 metric tons – series K	42
Tandem transport trolleys for loads up to 60 metric tons – series G	43
Twistlock / „Weld-on Cone“ transport of containers up to 60 metric tons	44
Air-powered trolley – for loads up to 30 metric tons	50
Electric-powered trolleys – for loads up to 50 metric tons	52
Transport trolleys for loads up to 60 metric tons – series G	58
Transport trolleys for loads up to 200 metric tons – series H	60
Accessories for forklifts	62
Sturdy castors for any application	64
Useful accessories for transport trolleys	66
Hydro-transporter	69
Optional galvanized equipment and custom solutions	70

**LIFT**  
**SAFELY.**

Easy. Handy. Strong.



**JUNG**

# » THE LIGHT-WEIGHT JACK:

# JH-G

Professional solutions. For professionals.



### FLEXIBLE

Removable handle on JH 6 G plus and JH 10 G plus.

### EXPANDABLE

Available with side handles and/or with standard handle

### LOW COST

Easy maintenance by single removable pump unit; safety pressure relief valve with dirt filter prevents overloading. Also available without integrated pump unit. See JH G plus series EX version.

### MAXIMUM OUTPUT

Maximum output due to reduced friction in the lifting track with our patented slide shoe design.

**i** Technical drawings of the respective devices can be found at [jung-hebetechnik.de](http://jung-hebetechnik.de)

### SAVE WEIGHT

Extreme weight reduction by improved construction.

### PATENTED

Work and lift safely with our patented lifting toe system (Pat. No. 4413478).

### SECURE AND TEAR RESISTANT

Swiveling safety toe made from die-forged steel for extreme robustness that prevents fractures. The advanced strength steel is impact resistant and provides optimal safety.

### RELIABLE STURDY

Sturdy, 180° swivelling feet - for easy and safe positioning in every situation.



» Swiveling lifting toe for safe and optimal adjustment to loads on varying inclines up to +6°.

# JACKS SERIES JH-G PLUS EX

Without integrated pump unit, for loads up to 30 metric tons

### i DESCRIPTION

- Integrated spring return retracts piston automatically (see picture 1) on JH 15 up to JH 30 G plus Ex.
- Reduced maintenance costs due to removable stroke unit and easy to change slide shoes.
- Slide shoe design inside the guiding track prevents twisting of the piston inside the lifting cylinder. This guarantees better force distribution, less friction and reduced wear compared to conventional jacks (see pict. 2).
- Extremely lightweight with high performance due to the use of high-quality material and innovative design.
- Continuous adjustment to the load due to swiveling safety toe. Secure stability in every situation even in lifted position (see picture 3).

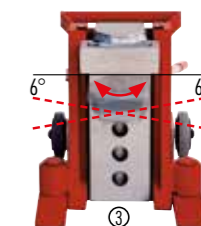
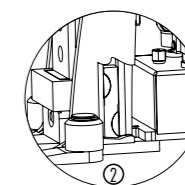
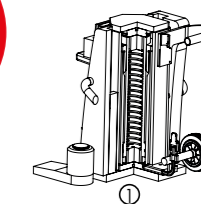

» External pump necessary. Please refer to page 22 for electrical pumps, page 23 for hand pumps, for hydraulic hoses to page 24.



TYPE		JH 10 G PLUS EX	JH 15 G PLUS EX	JH 20 G PLUS EX	JH 30 G PLUS EX
Load capacity on top plate	kg	10 000	15 000	20 000	30 000
Stroke	mm	150	175	190	200
Minimum lift toe height	h 1 mm	15	20	20	20
Maximum lift toe height	h 2 mm	180	205	225	305
Lift toe adjustment	V mm	5 x 41	5 x 46	5 x 51	5 x 71
Top plate height	H 1 mm	275	310	340	420
Toe width front	L b mm	60	80	80	80
Toe depth	n L mm	55	66	66	66
Length feet in front	L 2 mm	270	340	360	380
Length feet on side	L 1 mm	210	230	230	270
Width	B mm	247	300	322	375
Height	H 2 mm	310	310	340	420
Cylinder volume	Liter	0,3	0,5	0,73	1,27
Weight	kg	24	41	55	92
Order No.		11 610 106-G	11 615 106-G	11 620 106-G	11 630 106-G



# JACKS SERIES JH-G PLUS

With integrated pump unit, for loads up to 20 metric tons

## **i** DESCRIPTION

■ Slide shoe design inside the guiding track prevents twisting of the piston inside the lifting cylinder. This guarantees better force distribution, less friction and reduced wear compared to conventional jacks (see pict. 2).

■ JH 15/JH 20 G plus serial outfitted with fast stroke. Also available with spring return.

■ Reduced maintenance costs due to easy change slide shoes and removable pump unit.

■ Extremely lightweight with high performance due to the use of highquality material and innovative design.

■ Continuous adjustment to the load due to swiveling safety toe. Secure stability in every situation even in lifted position (see picture 3).

■ Die-forged steel toe provides impact resistance.

■ Safe operation due to ergonomic lowering screw.

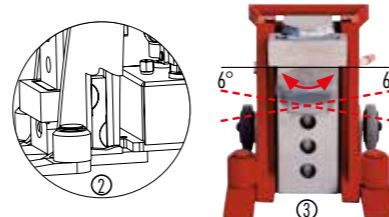

JH 15 G plus in use combined with our JL 9 K



JH 6 G plus with standard handle and side handles  
Right: JH 10 G plus with side handles, without standard handle

For information on matching  
**ACCESSORIES**  
see Page 24.

TYPE		JH 6 G PLUS	JH 10 G PLUS	JH 10 G PLUS KU
Load capacity on top plate	kg	6 000	10 000	10 000
Stroke	mm	140	150	108
Minimum lift toe height	h 1 mm	12	15	15
Maximum lift toe height	h 2 mm	157	180	138
Lift toe adjustment	V mm	6 x 29	5 x 41	4 x 41
Top plate height	H 1 mm	245	275	235
Toe width front	L b mm	50	60	60
Toe depth	n L mm	50	55	55
Length feet in front	L 2 mm	326	346	346
Length feet on side	L 1 mm	311	330	330
Width	B mm	233	247	247
Height	H 2 mm	280	310	235
Cylinder volume	Liter	0,18	0,3	0,21
Weight	kg	23	29	26
<b>ORDER NO.</b>		■ 01 060 102-G	■ 01 100 102-G	■ 01 100 103-G KU
<b>ORDER NO. with side handles and standard handle</b>		■ 01 060 102-G-B	■ 01 100 102-G-B	-
<b>ORDER NO. with side handles and without standard handle</b>		■ 01 060 102-G-G	■ 01 100 102-G-G	-



TYPE		JH 15 G PLUS	JH 20 G PLUS
Load capacity on top plate	kg	15 000	20 000
Stroke	mm	175	190
Minimum lift toe height	h 1 mm	20	20
Maximum lift toe height	h 2 mm	205	225
Lift toe adjustment	V mm	5 x 46	5 x 51
Top plate height	H 1 mm	310	340
Toe width front	L b mm	80	80
Toe depth	n L mm	66	66
Length feet in front	L 2 mm	415	425
Length feet on side	L 1 mm	401	405
Width	B mm	300	322
Height	H 2 mm	310	340
Cylinder volume	Liter	0,5	0,73
Weight	kg	48	60
<b>ORDER NO.</b>		■ 01 150 102-G	■ 01 200 102-G

# HYDRAULIC JACK SETS SERIES JHS

For loads up to 20 metric tons

## i DESCRIPTION

- 180° revolving housing, this allows the jack to be placed with long or with short feet to the load, if there is no space available under it.
- Safe: because of the use of a separate pump and hoses, more safety distance to the load.
- Extra-large lift height: JHS 5 with lift toe 250 mm, with top plate maximum 585 mm. JHS 10 with lift toe 260 mm, with top plate maximum 610 mm.
- Can also be used horizontally for pressing.
- Large load capacity – up to 20 metric tons in set - with low net weight, therefore perfect for use on site or on the way due to easy change of location of location.

- JHS 10 ku as set (JSET 20/3 ku) suits perfectly to the container transport trolleys (see page 46).
- High capacity at low weight.
- Swiveling lifting toe assures optimal adjustment to the load, along with safe and stable support even in raised position (see picture page 14).
- Pump unit separated from jack, flexible use, ideal also for confined spaces, also operates in horizontal position.
- Swiveling elbowed nipple allows hose connection from various directions.



HYDRAULIC JACKS WITH PUMP AND HOSES IN ONE SET				
TYPE	JSET 5/2	JSET 10/2	JSET 10/3	JSET 20/3
Jack	1 x JHS 5	2 x JHS 5	1 x JHS 10	2 x JHS 10
Hose	1 x JS 2	2 x JS 2	1 x JS 3	2 x JS 3
Pump	JP 26	JP 26	JP 26	JP 26
<b>ORDER NO.</b>	<b>20 405 200-S</b>	<b>20 410 200-S</b>	<b>20 410 301-S</b>	<b>20 420 301-S</b>

SINGLE HYDRAULIC JACKS JHS WITHOUT PUMP AND HOSE				
TYPE	JHS 5		JHS 10	
Load capacity on top plate		kg	5 000	10 000
Minimum lift toe height	h 1	mm	15	20
Maximum lift toe height	h 2	mm	250	260
Top plate height	H 1	mm	350	370
Maximum top plate height	H 2	mm	585	610
Toe width front	L b	mm	45	60
Useable toe depth	n L	mm	40	55
Diameter top plate	d	mm	60	80
Length toe supported	L 2	mm	170	205
Length toe exposed	L 1	mm	220	260
Width	B	mm	145	200
Cylinder volume	L		0,3	0,47
Weight		kg	10	19
<b>ORDER NO.</b>	<b>01 020 050-0</b>		<b>01 020 101-0</b>	

External pump necessary. Please refer to page 22 for electrical pumps, page 23 for hand pumps, for hydraulic hoses to page 24.

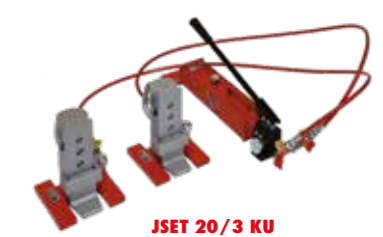

HYDRAULIC JACKS WITH PUMP AND HOSES IN ONE SET		
TYPE	JSET 10/3 KU	JSET 20/3 KU
Jack	1 x JHS 10 ku	2 x JHS 10 ku
Hose	1 x JS 3	2 x JS 3
Pump	JP 26	JP 26
<b>ORDER NO.</b>	<b>20 410 305-S</b>	<b>20 420 305-S</b>

SINGLE HYDRAULIC JACK JHS 10 KU WITHOUT PUMP AND HOSE				
TYPE	JHS 10 KU			
Load capacity on top plate		kg	10 000	
Minimum lift toe height	h 1	mm	20	
Maximum lift toe height	h 2	mm	288	
Lift toe adjustment	V	mm	5 x 41	
Top plate height	H 1	mm	265	
Maximum top plate height	H 2	mm	373	
Toe width front	L b	mm	60	
Useable toe depth	n L	mm	55	
Diameter top plate	d	mm	95	
Length toe supported	L 2	mm	205	
Length toe exposed	L 1	mm	260	
Width	B	mm	200	
Cylinder volume		Liter	0,21	
Weight		kg	19	
<b>ORDER NO.</b>	<b>01 020 105-0</b>			

# HYDRAULIC PRESSURE BLOCKS JD

## Safe and powerful

### WARNING! DANGER OF TILTING WITHOUT HYDRAULIC PRESSURE BLOCK

When lifting manually with four independent jacks, the load can tip over. The danger is even greater when lowering the load as this happens faster than lifting. Tipping the cargo can be the consequence.

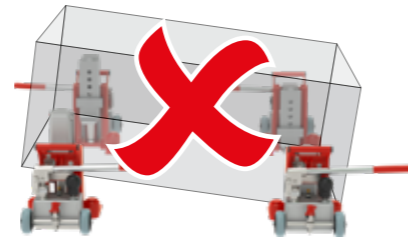

### Safety with hydraulic pressure block

Advantages of working with hydraulic pressure block:

- Safer working without danger of tilting
- Time-saving
- One-person-operation

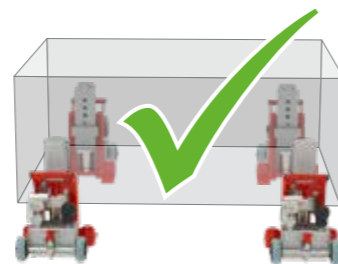

### THE FOLLOWING TYPES OF PRESSURE BLOCKS ARE AVAILABLE:

TYPE	JD 40+	JD 40 E+ VS	JD 80 E+ VS
with electrical pump on a cart	no	yes	yes
Spring return	no	yes	yes
Dimensions length	l mm	1 400	1 800
Dimensions width	b mm	350	660
Dimensions height	h mm	250	1 350
Working pressure	bar	520	520
<b>ORDER NO.</b>	■ 04 450 403-D	■ 04 400 403-D	■ 04 800 405-D

Customised solutions available on request

### **i** DESCRIPTION

- Synchronized lifting and lowering of multiple jacks. For loads with decentralized center of gravity. Simple and safe.
- Easy operation via push button (remote control).
- All slave-cylinders equipped with 520 bar safety pressure valves. Controls monitor pressure switches with LED indicator preventing any possible overloading.
- Clear and simple control unit, adjustable to control all or individual jacks. Also configurable for using three-point lifting system.
- The complete system is mobile and conveniently mounted on a cart.
- Retracting of the hydraulic jacks also without load (JH 15 - 20 G plus EX).
- Load independent, maintains constant lifting speed.
- Controllable lowering speed.
- Electrical pump JPE 30 and VS-control unit for driving individual lifting devices.
- Oil volume in the system JD 40 E+ VS is sufficient for up to 4 pcs. JH 10 G plus / JH 10 G plus EX / JHS 10. Larger jacks can be operated, but you need to lift twice to reach the full stroke.
- The cylinders in the pressure block are outfitted with spring returns to retract the pistons automatically.



Pressure block JD 40 E+ VS in action

JACKS TO USE WITH PRESSURE BLOCK JD 40 E+ VS	LOAD CAPACITY IN KG
4x JH 6 G plus (full stroke, without spring return)	24 000
4x JHS 5 (full stroke, without spring return)	20 000
4x JH 10 G plus (full stroke, without spring return)	40 000
4x JHS 10/JH 10 G plus ku (full stroke, without spring return)	40 000
4x JH 15 G plus (lift twice to reach full stroke, without spring return)	60 000
4x JH 15 G plus EX (lift twice to reach full stroke, with spring return)	60 000
4x JH 20 G plus (lift twice to reach full stroke, without spring return)	80 000
4x JH 20 G plus EX (lift twice to reach full stroke, with spring return)	80 000

# ELECTRICAL PUMPS

## JPE

See pages 15-19 for suitable jacks and page 24 for hydraulic hoses.

### Powerful and quick

#### DESCRIPTION

- Quick connectors with drip free rapid closure valves.
- One oil circuit capable of supplying two or four hydraulic jacks.
- Easily controllable: JPE 30-NVR with precision lowering regulator.
- Sturdy two stage electric pumps available in different versions.



Electric pump JPE 30-NVR with 2 jacks in operation.

- Easy handling.
- Includes transport cart for easy and safe transport.
- Also available as 110 V, 50 Hz.
- Maximum safety during operation due to cable remote control.

**JPE 30 NVR**

**Standard version**  
Equipped with 2 hydraulic connections with precise adjustable needle valves and 1 manometer.

**JPE 30/4 NVR**

**Extended version**  
Equipped with 4 hydraulic connections, each equipped with precise adjustable needle valves and 1 manometer.

Recommendation: If lifting one side of a load with 2 jacks use electrical pump type JPE, external manual pump JP 26 or air hydraulic pump JPL 15 (see page 23).



#### ELECTRICAL PUMPS WITHOUT HOSES

TYPE		JPE 30 NVR	JPE 30/4 NVR
Oil volume complete/usable	L	7,6/4,8	7,6/4,8
Working pressure	bar	520	520
Connections	pcs.	2	4
Flow rate low pressure	L/min.	3,9 - 7 bar	3,9 - 7 bar
Flow rate high pressure	L/min.	0,33 - 520 bar	0,33 - 520 bar
Motor facts		230 V, 50 Hz, 5 A	230 V, 50 Hz, 5 A
Dimensions L x W x H*	mm	680*(900**) x 330 x 600	680*(900**) x 330 x 600
Weight with oil and cart	kg	38	41
Usable jacks		any hydraulic jacks	any hydraulic jacks
<b>ORDER NO.</b>		<b>03 300 202-EU</b>	<b>03 300 402-EU</b>

\*Without push handle \*\*With push handle

# HAND PUMP JP AND AIR HYDRAULIC PUMP JPL



### Light and sturdy

#### DESCRIPTION

- Sturdy construction, yet light-weight and easy to handle.
- Pressure limiting valve provides safety against overloading.
- Optimally compatible with our hydraulic jacks.
- JPL 15 with adjustable working pressure.
- Pumps are equipped with integrated quick-lift for faster working.

**RECOMMENDED**  
for use with two jacks



Application with JP 26 and JHS 10

#### SUITABLE JACKS TO USE WITH A HAND PUMP/AIR HYDRAULIC PUMP

JACKS	JP 26	JPL 15
JH 6 G plus	2 x	2 x
JH 10 G plus / G plus ku / G plus EX	2 x	2 x
JH 15 G plus / G plus EX	2 x	2 x
JH 20 G plus / G plus EX	2 x	2 x
JH 30 G plus EX	1 x	1 x
JHS 5	2 x	2 x
JHS 10	2 x	2 x
JHS 10 ku	2 x	2 x



For information on matching  
**ACCESSORIES**  
see Page 24.



#### HYDRAULIC HAND PUMPS

#### AIR HYDRAULIC PUMPS

TYPE		JP 26	JPL 15
Oil volume complete/usable	L	2,3/2,2	1,5/1,5
Working pressure	bar	520	0-700**
Flow rate without load	L / min	-	1,07
Flow rate with load	L / min	-	0,18
Air connection	bar	-	7-14
Flow rate per stroke	L	0,0132 (0-14 bar)/0,0023 (14-520 bar)	-
Connections	pcs.	2	2
Dimensions L x W x H	mm	770 x 170* x 169	380 x 136 x 185
Weight	kg	13,0	9,0

**ORDER NO.** **02 260 000-P** **02 150 000-PL**

\*Width foot plate \*\*adjustable

# USEFUL ACCESSORIES

For hydraulic jacks and pumps



	DIMENSIONS	CATALOGUE PAGE	ORDER NO.
01. Manometer for pumps	Ø 63 mm	22-23	94 040 024-E
02. Handle for JH 10 G plus ku and 6/10 G plus To screw on attachment – for jacks	H x W x L mm 110 x 125 x 55	16	91 106 260-B
03. Plug-on manometer For pressure testing or pressure monitoring jacks	Ø 63 mm	15-17	94 001 024-B
04. Assembly of hollow piston with spring return Re-fitting of hydraulic jacks type JH 15 G Plus Re-fitting of hydraulic jacks type JH 20 G Plus	Ø 60 mm	17	91 156 457-B
	Ø 70 mm	17	91 206 457-B
05. Special toe for ISO-containers For JH 6 G plus For JH 10 G plus For JH 15 G plus	87 x 80 x 90 mm	16	91 999 060-B
	90 x 85 x 100 mm	17	91 999 100-B
	98 x 110 x 110 mm	17	91 999 150-B
06. Adapter for hose extension JS All hoses	120 mm	24	15 999 001-NN

HYDRAULIC HOSES FOR OUR HAND PUMP, AIR HYDRAULIC PUMP, AND ELECTRICAL PUMPS:

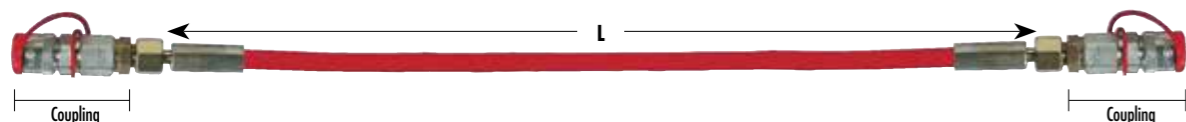

Hydraulic hose (safety factor 4:1), max. working pressure 700 bar, oil-filled, ready for use

TYPE		JS 2	JS 3	JS 4	JS 6	JS ...
Drip free couplings	no.	2	2	2	2	2
Length	L = mm	2 000	3 000	4 000	6 000	variable*
ORDER NO.		15 200 002-0	15 300 002-0	15 400 002-0	15 600 002-0	15 ...-002**

\*available up to 15000 mm \*\*... = ...enter L in cm

# TRANSPORT-TROLLEYS

Technical drawings of the respective devices can be found at [jung-hebetechnik.de](http://jung-hebetechnik.de)

Move safely.

PRACTICAL

OPTIMAL STEERING

INNOVATIVE

Optimal capacity and weight ratio due to innovative construction.

Steering rod with handle, from 6 t with towing eye.

Steerable trolley equipped with ball bearing supported turntable.

SAFELY LOADED

Steel clasps on steerable trolleys JL 12 K, JL 14 K, JLB 16 S, JLB 24 S, JLB 15 G, JLB 20 G, JLB 30 G, JLB 40 H, JLB 60 H and JL 80 H for easy loading and unloading from/into vehicles.

HIGH-QUALITY

High quality castors with precision ball bearings and extremely durable coating. Series K and G with aluminium core for reduced weight.

DIRECTIONAL STABILITY

Connecting bars guarantee alignment of castors even in curves, models 6 metric tons and up with joint.

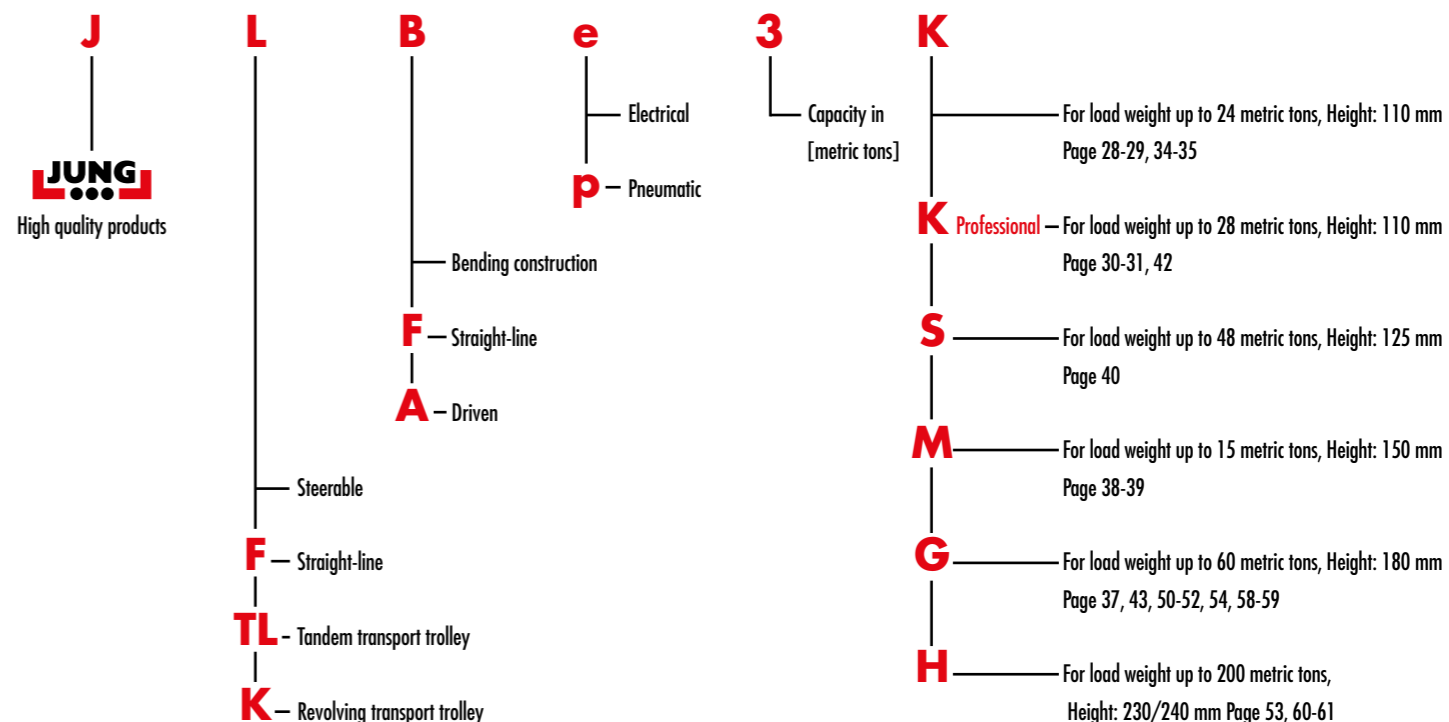

**JUST  
MOVE.**

Ergonomic. Effort-saving. Efficient.

**JUNG**



# TRANSPORT TROLLEYS SERIES K

For loads up to 24 metric tons, height: 110 mm

## DESCRIPTION

- Equipped with highest quality castors as standard.
- Reduced weight due to advanced construction of load cassettes.
- Non-marking support wheels.
- The K-series towing bars are also available with a removable handle. The removable handle is also available as a re-fitting set.
- All transport trolleys are ready for use: The steerable transport trolley is fitted with a ball bearing supported turntable and a handlebar. The adjustable-width transport trolley consists of two transport units and connecting bar.



Castors with ball bearings guarantee easy movement.

## EXAMPLE FOR LOAD DISTRIBUTION 12 metric tons trolley combination:

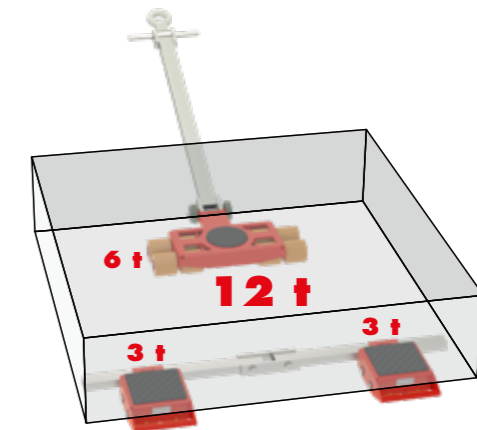

TYPE	Lloads up to	6 t		12 t	
		JLB 3 K	JFB 3 K	JLB 6 K	JFB 6 K
Load capacity	kg	3 000	2 x 1 500	6 000	2 x 3 000
Number of castors	Pieces	4	4	8	8
Castor dimensions	Ø x l mm	85 x 85	85 x 85	85 x 85	85 x 85
Height	mm	110	110	110	110
Supporting surface per cassette	E x F mm		120 x 80		170 x 170
Cassette dimensions	L2 x B2 mm		190 x 115		325 x 200
Connecting bar with joint	Length mm		1 000**		1 230
Cassettes adjustable from - to	G - H mm		125-880		400-1 030
Supporting surface of turntable	Ø C mm		150		150
Dimensions	L1 x B1 mm		225 x 280		445 x 590
Handlebar with pulling eye	Length mm		990*		1 210
Weight JUWathan®plus	kg		12		11
					33
					25
ORDER NO.		07 031 085-V	08 031 085-V	07 061 085-V	08 061 085-V

\*JLB 3 K steering bar without pulling eye \*\*JFB 3 K connecting bar without joint



TYPE	Lloads up to	18 t		24 t	
		JL 9 K	JFB 9 K	JL 12 K	JFB 12 K
Load capacity	kg	9 000	2 x 4 500	12 000	2 x 6 000
Number of castors	Pieces	12	12	16	16
Castor dimensions	Ø x l mm	85 x 85	85 x 85	85 x 85	85 x 85
Height	mm	110	110	110	110
Supporting surface per cassette	E x F mm		170 x 170		170 x 170
Cassette dimensions	L2 x B2 mm		325 x 390		325 x 390
Connecting bar with joint	Length mm		1 230		1 230
Cassettes adjustable from - to	G - H mm		400-1 030		400-1 030
Supporting surface of turntable	Ø C mm		170		170
Dimensions	L1 x B1 mm		580 x 820		580 x 1 000
Handlebar with pulling eye	Length mm		1 210		1 210
Weight JUWathan®plus	kg		54		32
					64
					35
ORDER NO.		07 090 085-V	08 091 085-V	07 120 085-V	08 121 085-V

# TRANSPORT TROLLEYS SERIES K PROFESSIONAL

For loads up to 28 metric tons, Height: 110 mm

## i DESCRIPTION

■ The double castor design results in dramatically easier steering due to reduced friction forces in curves. The much lower friction resistance also causes the trolleys on the rear axis to follow in a true to track course.

■ Non-marking support wheels.

■ Higher capacity with professional castors, at same dimension as series K trolleys.

■ The series K handle bars are now also available with a removable handle, which is also available as a re-fitting set.

■ All transport trolleys are ready for use: the steerable transport trolley is fitted with a ball bearing supported turntable and a handlebar. The adjustable-width transport trolley consists of two transport units and connecting bar.

■ Because of the professional castors you need 30% less power for steering.



Castors with ball bearings guarantee easy movement.

## ▶ EXAMPLE FOR LOAD DISTRIBUTION 14 metric tons trolley combination:

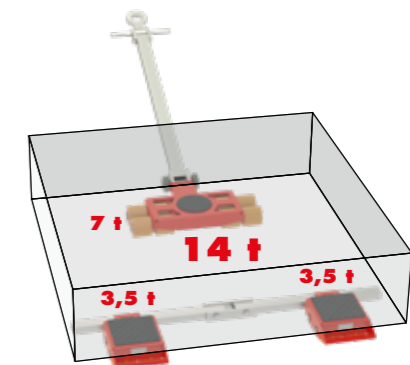

Loads up to		14 t		20 t	
TYPE		JLB 7 K	JFB 7 K	JL 10 K	JFB 10 K
Load capacity	kg	7 000	2 x 3 500	10 000	2 x 5 000
Number of twin castors	Pieces	8	8	12	12
Castor dimensions	Ø x l mm	85 x 85	85 x 85	85 x 85	85 x 85
Height	mm	110	110	110	110
Supporting surface per cassette	E x F mm		170 x 170		170 x 170
Cassette dimensions	L2 x B2 mm		325 x 200		325 x 390
Connecting bar with joint	Length mm		1 230		1 230
Cassettes adjustable from - to	G - H mm		400-1 030		400-1 030
Supporting surface of turntable	Ø C mm		150		170
Dimensions	L1 x B1 mm		445 x 590		580 x 820
Handlebar with pulling eye	Length mm		1 210		1 210
Weight Professional	kg		35		27
ORDER NO.		07 071 085-D	08 071 085-D	07 100 085-D	08 101 085-D

Loads up to		28 t	
TYPE		JL 14 K	JFB 14 K
Load capacity	kg	14 000	2 x 7 000
Number of twin castors	Pieces	16	16
Castor dimensions	Ø x l mm	85 x 85	85 x 85
Height	mm	110	110
Supporting surface per cassette	E x F mm		170 x 170
Cassette dimensions	L2 x B2 mm		325 x 390
Connecting bar with joint	Length mm		1 230
Cassettes adjustable from - to	G - H mm		400-1 030
Supporting surface of turntable	Ø C mm		170
Dimensions	L1 x B1 mm		580 x 1 000
Handlebar with pulling eye	Length mm		1 210
Weight Professional	kg		65
ORDER NO.		07 140 085-D	08 141 085-D



# MOVE FLEXIBLY.

Agile. Easy. Efficient.



**JUNG**

# REVOLVING TRANSPORT TROLLEYS JKB

For loads up to 12 metric tons, height 110 mm

## i DESCRIPTION

- Optional connecting bars can be fixed without tools by clamping down on adapter.
- High load capacity at low weight.
- Bearing supported swiveling castors allow 360° maneuverability.
- Mix and match revolving trolleys with transport trolleys: JKB 1,5 to JKB 7,5 have same height as transport trolleys series K.
- All products are also available in a set of two with price advantage.
- In addition, all the trolleys have a platform center hole to allow attachment to the load.
- Using the slots in the platform, the trolleys JKB 3 - 7,5 can be affixed to the load with standard lashing belts.
- Pulling handle and connecting bars available as accessories (see pages 66-67).
- Unrivalled: The narrow castors reduce rolling and turning resistance to a minimum.
- For choosing the adequate revolving trolley we recommend a load of two-third of the maximum capacity. This will be the most advantageous compromise between payload, ergonomics and handling of the devices.



Revolving trolley JKB in action.

## ▶ EXAMPLE FOR LOAD DISTRIBUTION 9 metric tons trolley combination: ◀

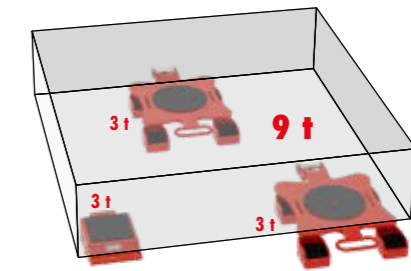

Loads up to		1,5 t	3 t	3 t	6 t
TYPE		JKB 1,5 K	JKB 1,5 SET	JKB 3 K	JKB 3 SET
Consist of		1 x JKB 1,5 K	2 x JKB 1,5 K	1 x JKB 3 K	2 x JKB 3 K
Load capacity	kg	1 500	2 x 1 500	3 000	2 x 3 000
Number of castors	Pieces	6	2 x 6	8	2 x 8
Castor dimensions	Ø x l mm	85 x 43	85 x 43	85 x 43	85 x 43
Height	mm	110	110	110	110
Supporting surface per cassette	Ø C mm	150	150	250	250
Cassette dimensions	L1 x B1 mm	530 x 490	530 x 490	675 x 435	675 x 435
Weight JUWAmid	kg	20	40	36	72
<b>ORDER NO. with JUWAmid</b>		■ 14 015 085-P	■ 14 015 085-D	■ 14 031 085-P	■ 14 031 085-D
<b>ORDER NO. with JUWAtan®</b>		■ 14 015 085-VU	■ 14 015 085-DVU	■ 14 031 085-VU	■ 14 031 085-DVU



Loads up to		4 t	8 t	6 t	12 t
TYPE		JKB 4 K	JKB 4 SET	JKB 6 K	JKB 6 SET
Consist of		1 x JKB 4 K	2 x JKB 4 K	1 x JKB 6 K	2 x JKB 6 K
Load capacity	kg	4 000	2 x 4 000	6 000	2 x 6 000
Number of castors	Pieces	12	2 x 12	16	2 x 16
Castor dimensions	Ø x l mm	85 x 43	85 x 43	85 x 43	85 x 43
Height	mm	110	110	110	110
Supporting surface per cassette	Ø C mm	250	250	250	250
Cassette dimensions	L1 x B1 mm	675 x 475	675 x 475	675 x 525	675 x 525
Weight JUWAmid	kg	38	76	41	82
<b>ORDER NO. with JUWAmid</b>		■ 14 041 085-P	■ 14 041 085-D	■ 14 061 085-P	■ 14 061 085-D
<b>ORDER NO. with JUWAtan®</b>		■ 14 041 085-VU	■ 14 041 085-DVU	■ 14 061 085-VU	■ 14 061 085-DVU

# REVOLVING TRANSPORT TROLLEYS JKB

For loads up to 28 t metric tons, height 110 mm/180 mm

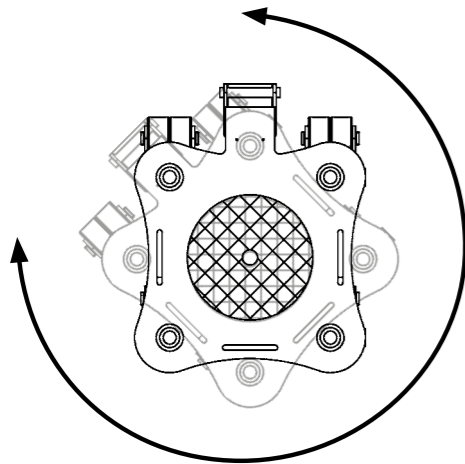

360° rotation in all directions



Revolving trolley JKB in action

## i DESCRIPTION

- JKB 10 G/JKB 14 G have same height as transport trolleys series G.
- Connecting bars as standard 2000 mm, can be offered up to 3 m length.
- High load capacity at low weight.
- Bearing supported swiveling castors allow 360° maneuverability.
- All products are also available in a set of two with price advantage.
- In addition, all the trolleys have a platform center hole to allow attachment to the load.
- Unrivalled: The narrow castors reduce rolling and turning resistance to a minimum.
- Pulling handle and connecting bars available as accessories (see pages 66-67).
- For choosing the adequate revolving trolley we recommend a load of two-third of the maximum capacity. This will be the most advantageous compromise between payload, ergonomics and handling of the devices.

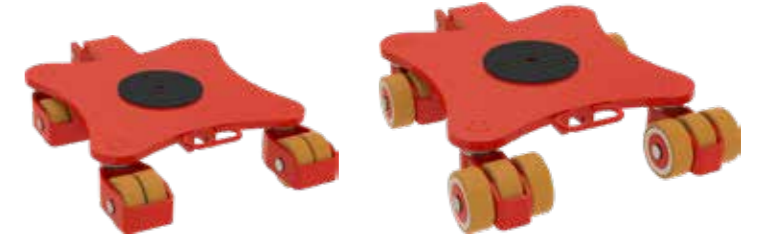

Loads up to		7,5 t	15 t
TYPE		■ JKB 7,5 K	■ JKB 7,5 SET
Consist of		1 x JKB 7,5 K	2 x JKB 7,5 K
Load capacity	kg	7 500	2 x 7 500
Number of castors	Pieces	20	2 x 20
Castor dimensions	Ø x l mm	85 x 43	85 x 43
Height	mm	110	110
Supporting surface per cassette	Ø C mm	250	250
Cassette dimensions	L1 x B1 mm	895 x 740	895 x 740
Weight JUWAmid	kg	64	128
<b>ORDER NO. with JUWAmid</b>		■ 14 075 085-P	■ 14 075 085-D
<b>ORDER NO. with JUWAtan®</b>		■ 14 075 085-VU	■ 14 075 085-DVU

Loads up to		10 t	20 t	14 t	28 t
TYPE		■ JKB 10 G	■ JKB 10 SET	■ JKB 14 G	■ JKB 14 SET
Consist of		1 x JKB 10 G	2 x JKB 10 G	1 x JKB 14 G	2 x JKB 14 G
Load capacity	kg	10 000	2 x 10 000	14 000	2 x 14 000
Number of castors	Pieces	8	2 x 8	12	2 x 12
Castor dimensions	Ø x l mm	140 x 59	140 x 59	140 x 59	140 x 59
Height	mm	180	180	180	180
Supporting surface per cassette	Ø C mm	250	250	250	250
Cassette dimensions	L1 x B1 mm	975 x 665	975 x 665	975 x 720	975 x 720
Weight JUWAtan®	kg	140	280	148	296
<b>ORDER NO. with JUWAtan®</b>		■ 14 101 140-VU	■ 14 101 140-DVU	■ 14 140 140-VU	■ 14 140 140-DVU

# MULTI-PURPOSE TROLLEYS SERIES M

For loads up to 15 metric tons, height 150 mm

## DESCRIPTION

- Combines leading swiveling castors with trailing rigid castors. Swiveling lead-castors make steering easier by up to 80%.
- Ergonomic: Reduces handling effort for user.
- Better directional stability on long straight-line paths with trailing rigid castors.
- Trolleys can be used as steerable, adjustable or tandem trolley.
- Low installation height. Low weight.
- Extreme maneuverable with thrust bearing supported, anti-slip turntable.
- Ideal for transporting loads on slalom paths including 90° true-to-course straightline, turning and sideways maneuvering.
- Floor protective, non-marking coating.
- Each trolley can be used for either steerable or straight-line movements.
- An additional pulling handle for steering of rear-trailing trolleys for tighter turning radius is included in the set



Example as tandem transport trolley



Example as adjustable trolley

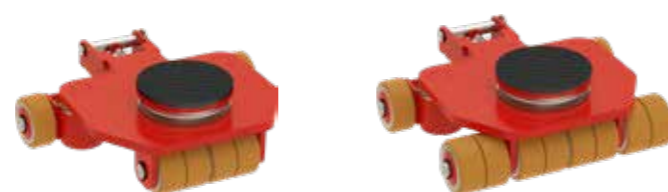

Loads up to		3,5 t	5 t
TYPE		JLF 3,5	JLF 5
Load capacity	kg	3 500	5 000
Number of castors / twin castors	Pieces	4/2	4/4
Castor dimensions	mm	85 x 43	85 x 43
Height	mm	150	150
Supporting surface per cassette	Ø C mm	150	150
Dimensions	L1 x B1 mm	410 x 420	410 x 420
Handlebar with pulling eye		-	-
Connecting bar		-	-
Weight JUWathan®plus	kg	25	28
<b>ORDER NO.</b>		<b>16 035 085-D</b>	<b>16 050 085-D</b>

Registered design EU No. 002267487 - 001 European patent No. 2 662 261 B1



Loads up to		12 t	15 t
TYPE		JLF SET 12	JLF SET 15
Load capacity	kg	1 x 5 000 + 2 x 3 500	3 x 5 000
Number of castors/twin castors	Pieces	3 x 4/2 x 2 + 1 x 4	3 x 4/3 x 4
Castor dimensions	mm	85 x 43	85 x 43
Height	mm	150	150
Supporting surface per cassette	Ø C mm	150	150
Dimensions	L1 x B1 mm	410 x 420	410 x 420
Handlebar with pulling eye	L mm	1 210	1 210
Connecting bar	Ø x L mm	20 x 1 200	20 x 1 200
Weight JUWathan®plus	kg	95	102
<b>ORDER NO.</b>		<b>16 120 085-D</b>	<b>16 150 085-D</b>

# TRANSPORT TROLLEYS SERIES S

For loads up to 48 metric tons, height 125 mm



## **i** DESCRIPTION

■ Pivoting roller cassettes within the frame (except for JLB 16 S) assure even pressure distribution across all castors and across the floor.

■ Very low height at only 125 mm, with high capacity and low own weight.

■ All transport trolleys are ready for use: the steerable transport trolley is fitted with a ball bearing supported turntable and a handlebar (as shown in picture). The adjustable-width transport trolley consists of two transport units and connecting bars.

■ Slim castor design (60 mm fitting length) results in easier steering due to reduced friction forces also in curves.



Loads up to		32 t		48 t	
TYPE		JLB 16 S	JFB 16 S	JLB 24 S	JFB 24 S
Load capacity	kg	16 000	2 x 8 000	24 000	2 x 12 000
Number of castors	Stück	16	16	24	24
Castor dimensions	Ø x l mm	90 x 60	90 x 60	90 x 60	90 x 60
Height	mm	125	125	125	125
Supporting surface per cassette	E x F mm		200 x 220		200 x 220
Cassette dimensions	L2 x B2 mm		370 x 330		370 x 465
Connecting bar with joint	Length mm		2 x 1 540		2 x 1 540
Cassettes adjustable from - to	G - H mm		540-1 300		660-1 300
Supporting surface of turntable	Ø C mm	215		215	
Dimensions	L1 x B1 mm	580 x 805		580 x 1 156	
Handlebar with pulling eye	mm	1 230		1 480	
Weight JUWAtan®	kg	81	76	120	80
ORDER NO. with JUWAtan®		05 161 090-V	06 161 090-V	05 242 090-V	06 242 090-V
ORDER NO. with steel castors		05 161 090-S	06 161 090-S	05 242 090-S	06 242 090-S

# PROFESSIONALLY MOVED.

Safe. Simple. Flexible.



# TANDEM TROLLEYS SERIES K

For loads up to 14 metric tons, height 110 mm

## i DESCRIPTION

■ Tandem transport trolley for loads with no leading or trailing edge center support.

■ The double castors design results in dramatically easier steering due to reduced friction forces in curves. The much lower friction resistance also causes the castors on the rear axis follow in a true to track course.

■ Ready for use: delivery includes 2 steering units, 2 towing bars and 1 set of connecting rods.

■ Multi-purpose use: also usable as two single trolleys, each with half of the combined load capacity. No additional accessories needed.

■ Non-marking support wheels.

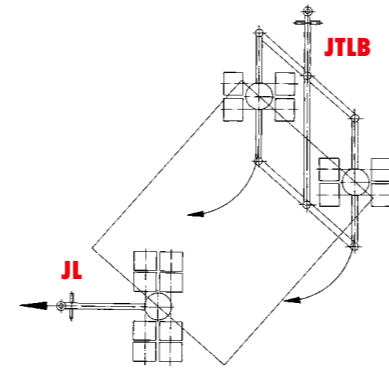

Example: For short radius curves steering possible up to 45°.



Loads up to		6 t	14 t
TYPE		JTLB 6 K	JTLB 14 K
Load capacity	kg	6 000	14 000
Number of twin castors	Pieces	8	16
Castor dimensions	Ø x l mm	85 x 85	85 x 85
Height	mm	110	110
Cassette dimensions	L2 x B2 mm	600 x 280	1 000 x 590
Supporting surface per cassette	Ø C mm	150	150
Connecting bar	E mm	1 000	1 400
Adjustable from - to Vmin. - Vmax.*	mm	560-960	660-1 340
Adjustable		5x	5x
Total length/width	L1 x B1 mm	760 x 1 240	1 070 x 1 580
Handlebar with pulling eye	Length mm	990**	1 210
Weight Professional	kg	46	104

ORDER NO. Professional      ■ 12 061 085-D      ■ 12 121 085-D

\*other lengths available on request    \*\*JTLB 6 without pulling eye

# TANDEM TROLLEYS SERIES G PROFESSIONAL

For loads up to 30 metric tons, height 180 mm

## i DESCRIPTION

■ Big castors Ø 140 mm x width 59 mm provide optimal rolling characteristics on uneven surfaces and rough pavements.

■ Safely overcomes small ledges, cracks in the concrete and countersunk rail tracks.

■ Custom solutions available.

■ Multi-purpose use: also usable as two single trolleys, each with half of the combined load capacity. No additional accessories needed. Comes with two towing bars.

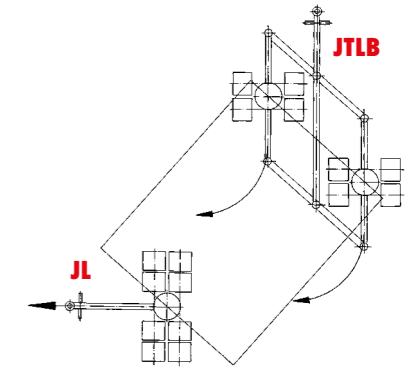

Example: For short radius curves steering possible up to 45°.

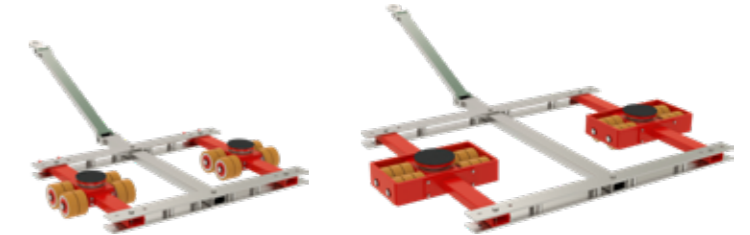

Loads up to		20 t	30 t
TYPE		JTL 20 G	JTLB 30 G
Load capacity	kg	20 000	30 000
Number of castors	Pieces	16	24
Castor dimensions	Ø x l mm	140 x 59	140 x 59
Height	mm	180	180
Supporting surface of turntable	Ø C mm	170	215
Cassette dimensions	L2 x B2 mm	1 020 x 440	1 328 x 610
Width of track and connection rod*	E mm	1 330	1 700
Adjustable from - to Vmin. - Vmax.	mm	900-1 230	1 270-1 600
Adjustable		3x	3x
Dimensions	L1 x B1 mm	1 260 x 1 670	1 620 x 2 200
Handlebar with pulling eye	Length mm	1 230	1 230
Weight JUWathan®plus	kg	168	283

ORDER NO. with JUWathan®plus      ■ 12 202 140-V      ■ 12 302 140-V2

\*other lengths available on request



# TANDEM TROLLEYS "WELD-ON CONE"

For transporting containers up to 28 metric tons, height 170 mm

## i DESCRIPTION

- „Weld-on Cone“ version for indoor container transport on smooth floors includes turntables fitted with cones and 2-parts container-wide connecting bars fixed length 2.26 m; also including a pulling handle with towing eye.
- Containers can be moved with extremely low installation height.
- Form-fitting-hold between the trolley and the containers (Weld-on Cone System).
- Compatible with all ISO-containers.
- Safe transport of containers.

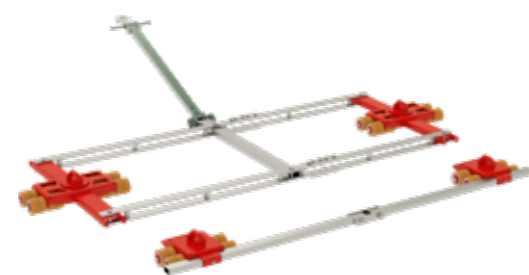

„Weld-on Cone“ system for Series K  
Please refer to pages 28-29, 34-35, 42 for technical details

TYPE	■ JTLB 14 K WOC		■ JFB 14 K WOC	
Height	h1	mm	110	110
Total height	h2	mm	170	170
ISO-length	V	mm	2260	2260
Dimensions steerable	L1 x B1	mm	1 120 x 2 850	-
Dimensions straight-line	L2 x B2	mm	-	325 x 2 650
<b>ORDER NO.</b>	■ 12 121 085-WZ		■ 08 141 085-WOC	

For information on matching  
**ACCES-SORIES**  
see Pages 66-67.

# TANDEM TROLLEYS TWISTLOCK

For transporting containers up to 60 metric tons, height 300 mm

## i DESCRIPTION

- „Twistlock“ version for outdoor transport for use on pavement includes turntables fitted with „Twistlock“ to secure containers to transport trolleys. Including 2-parts connecting bars fixed length 2.26 m and pulling handle with towing eye.
- Containers can be moved with extremely low installation height.
- Lock-to-hold mechanism between the trolley and the containers (Twistlock).
- Compatible with all ISO-containers.
- Safe transport of containers.



For information on matching  
**CASTORS**  
see pages 64-65.

Also  
**AVAILABLE**  
with extended track rods  
on request.

Twistlock system for Series G  
Please refer to page 35, 38-39 for technical details

TYPE	■ JTL 20 G TL		■ JFB 20 G TL		■ JTLB 30 G TL		■ JFB 30 G TL	
Height	h1	mm	215	215	215	215	215	215
Total height	h2	mm	300	300	300	300	300	300
ISO-length	V	mm	2260	2260	2260	2260	2260	2260
Dimensions steerable	L1 x B1	mm	1 260 x 2 700	-	1 620 x 2 870	-	-	-
Dimensions straight-line	L2 x B2	mm	-	460 x 3 000	-	-	460 x 3 000	-
<b>ORDER NO.</b>	■ 12 202 140-TL		■ 10 202 140-TL		■ 12 302 140-TL		■ 10 302 140-TL	

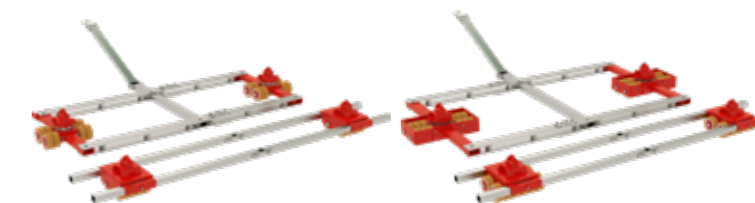

# CONTAINER-TRAVERSE

With Twistlock-fitting up to 36 metric tons, height 260 mm

## **i** DESCRIPTION

- Safe transport of ISO-containers and special containers up to 36 metric tons.
- Containers can be moved with extremely low installation height.
- Assembled in two parts for easy handling and storage.
- Compatible with all ISO containers.
- Lockable twistlock version to ISO dimension 2.26 m (not adjustable).
- Optionally a trapezium drawbar can be adapted.
- The dimension of the traverse is within the container contour.
- The load is firmly connected to the chassis and can be completely loaded.
- Installation height of the crossbar: 80 mm.



**CONTAINER-TRAVERSE SINGLE**  
ORDER NO.: 92 000 226-T1



**CONTAINER-TRAVERSE WITH DRAWBAR**  
ORDER NO.: 92 000 226-T2

## POSSIBLE COMBINATIONS:

Steerable trolleys	Trolleys	TOTAL LOAD CAPACITY IN KG*
2 x JKB 4 K	1 x JFB 7 K	15 000
2 x JKB 6 K	1 x JFB 10 K	22 000
2 x JKB 7,5 K	1 x JFB 14 K	29 000
1 x JTLB 14 K	1 x JFB 14 K	28 000
2 x JKB 10 G	1 x JFB 20 G	36 000
2 x JKB 14 G	1 x JFB 30 G	36 000
2 x JLF 5	2 x JLF 5	20 000
1 x JLAe 15/30 G	1 x JFB 15 G	30 000
1 x JLAe 25/50 H	1 x JFB 25 G	36 000
1 x JTL 20 G	1 x JFB 20 G	36 000
1 x JTLB 30 G	1 x JFB 30 G	36 000

\*Load must rest on the crossbar as a surface load

## POSSIBLE COMBINATIONS CONTAINER-TRAVERSE:



**JFB 30 G with traverse**

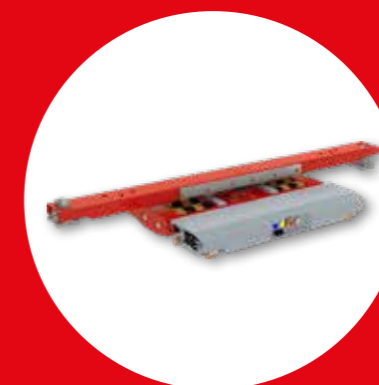

**JLA-e 15/30 G with traverse**



**JKB 10 G with traverse**

## EXAMPLE USAGE CONTAINER-TRAVERSE

Example: Container traverse suitable for standard tandem steering systems. The traverse is firmly connected to the turntables by screwing and thus forms a secure transport unit.



## JACK WITH SPECIAL TOE FOR CONTAINERS

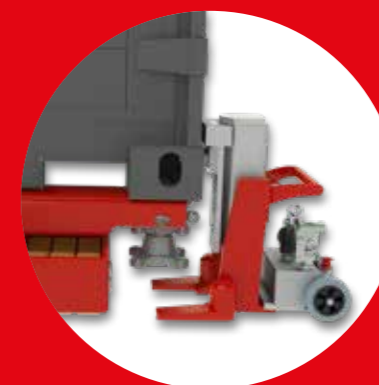
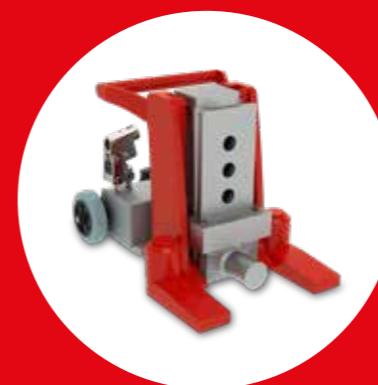

Hydraulic jack with special toe for containers: The special toe fits in the container corners for safe lifting of ISO containers, can also be upgraded. Available for all hydraulic jacks series JH-G plus and JHS 10 ku.



# MOVE INNOVATIVELY.

Flexible. Driven. Efficient.



**JUNG**

# TROLLEY AIR-POWERED

For loads up to 30 metric tons, height 180 mm

## **i** DESCRIPTION

- Ecofriendly, uses only compressed air.
- Spare a towing vehicle.
- Low maintenance propulsion system.
- No need to charge any batteries.
- 360° maneuverable.
- Compatible with G-series transport trolleys (page 58-59).
- All hoses are detachable for compact and easy transport.
- Quick set up. Connect air supply hose and go.
- Requires standard shop air connection with 8 bar (116 psi) and air volume of 1500 L/min (25 L/s) or (53 SCFM).
- Infinitely variable speed and direction.
- Model JLA-p 15 / 30 G includes the trolley and remote control unit.
- Two air motors are independently controllable by two joysticks.
- Maneuverability: Forward, reverse, in place turning.
- Higher capacities available on request.



Loads up to		15 t
TYPE		■ JLA-P 15/30 G
Load capacity	kg	15 000
Pulling capacity	kg	30 000
Number of castors	Pieces	16
Castor dimensions	Ø x l mm	140 x 59
Height	mm	180
Supporting surface per cassette	Ø C mm	215
Dimensions	L1 x B1 mm	650 x 1 000
Weight without control box	kg	175
Air consumption	L/sec.	25
Required air pressure	bar	8
<b>ORDER NO.</b>		■ 22 150 140-V

# TROLLEY SETS AIR-POWERED



## **i** TROLLEY SETS

- Set 2 includes:**
- JLA-p 15/30 G includes control unit
  - Hose cart complete with hose reel
  - 30 m air supply hose with Ø 19 mm
  - 1 Liter oil for pneumatic motors
  - 400 ml chain spray (not overseas)



Underside view of JLA trolley

- Set 3 additionally includes:**
- Transport trolley JFB 15 G (see page 58)



JLA Set in action



JLA SETS		■ JLA-P SET 2	■ JLA-P SET 3
TYPE			
JLA-p incl. control box		1 x	1 x
Hose length/diameter		30 m/19 mm	30 m/19 mm
Cart + oil + chain spray		1 x	1 x
JFB 15 G		-	1 x
<b>ORDER NO.</b>		■ 22 150 140-VP2	■ 22 150 140-VP3

# TROLLEYS

## ELECTRIC-POWERED

For loads up to 50 metric tons, height 180 mm/230 mm

### **i** DESCRIPTION

- Practical, with battery and handy remote control! The remote control can be switched from two-handed to one-handed operation (flexible left/right). The one-handed operation allows to move the trolley exactly straight ahead.
- Spare a towing vehicle.
- Very compact dimensions.
- Low charging time.  
JLA-e 5/12 G = 3-4 h;  
JLA-e 15/30 G = 5-7 h;  
JLA-e 25/50 H = 5-7 h;  
Alternatively high-speed charger = 2,5-3,5 h. Available as accessory.
- Batteries are interchangeable.
- High running time (at full load under ideal conditions) by direct-driven motor.
- 360° maneuverable.  
Infinitely variable speed.
- Compatible with series G (p. 58-59) and series H (p. 60-61). Transport trolleys are not included
- LiFePo4 battery technology.
- A cable remote control is available on request.



Combination of JUWAtan® and JUWAmid castors for optimal traction and steering characteristics.



Loads up to		12 t	30 t
TYPE		JLA-E 5/12 G	JLA-E 15/30 G
Load capacity	kg	5 000	15 000
Pulling capacity	kg	12 000	30 000
Number of castors	Pieces	4	16
Castor dimensions	Ø x l mm	140 x 59	140 x 59
Height	mm	180	180
Supporting surface of turnable	Ø C mm	150	215
Dimensions	L1 x B1 mm	760 x 880	860 x 1 200
Weight without battery + controller	kg	136	213
Weight battery + box	kg	36	90
Weight charger	kg	2	2
Speed	m/min	10	6,5
Operational time	h	3-4	5-6
Operating mode in acc. with VDE 0530		S1	S3 60%
Battery and charger	Pieces	1 x	1 x
Remote control, charger and belt with holder	Pieces	1 x	1 x
<b>ORDER NO.</b>		<b>22 005 100-G</b>	<b>22 015 100-G</b>



Loads up to		50 t
TYPE		JLA-E 25/50 H
Load capacity	kg	25 000
Pulling capacity	kg	50 000
Number of castors	Pieces	16
Castor dimensions	Ø x l mm	200 x 83
Height	mm	230
Supporting surface of turnable	Ø C mm	250
Dimensions	L1 x B1 mm	1 180 x 1 760
Weight without battery + controller	kg	593
Weight battery + box	kg	90
Weight charger	kg	2
Speed	m/min	10
Operational time	h	3-4
Operating mode in acc. with VDE 0530		S3 60%
Battery and charger	Pieces	1 x
Remote control, charger and belt with holder	Pieces	1 x
<b>ORDER NO.</b>		<b>22 025 100-H</b>

# TROLLEYS WITH STROKE ELECTRIC-POWERED

For loads up to 30 metric tons, height 180 mm/200 mm

## i DESCRIPTION

- Stroke max. 50 mm. The load can be moved in the extended state.
- Practical, with battery and handy remote control. The remote control can be switched from two-handed to one-handed operation (flexible left/right). The one-handed operation allows to move the trolley exactly straight ahead.
- High running time (at full load under ideal conditions) by direct-driven motor.
- Low charging time.  
JLA-e 5/12 G = 3-4 h;  
JLA-e 15/30 G = 5-7 h;  
Alternatively high-speed charger = 2,5-3,5 h. Available as accessory.
- Spare a towing vehicle
- 360° maneuverable.
- Infinitely variable speed.
- Very compact dimensions.
- Compatible with series G (p. 58-59). Transport trolleys are not included.
- LiFePo4 battery technology



For information on matching  
**ACCESSORIES**  
see Pages 66-67.

Loads up to		12 t	30 t
TYPE		JLA-E 5/12 G WITH STROKE	JLA-E 15/30 G WITH STROKE
Load capacity	kg	5 000	15 000
Pulling capacity	kg	12 000	30 000
Number of castors	Pieces	4	16
Castor dimensions	Ø x l mm	140 x 59	140 x 59
Height	mm	180	200
Stroke	mm	50	50
Supporting surface of turnable	Ø C mm	170	215
Dimensions	L1 x B1 mm	975 x 880	1 090 x 1 200
Weight with battery	kg	195	330
Speed	m/min	10	6,5
Operational time	h	3-4	5-6
Battery and charger	Pieces	1 x	1 x
Remote control, charger and belt with holder	Pieces	1 x	1 x

ORDER NO. ■ 22 005 101-G HUB ■ 22 015 101-G HUB

## i TROLLEY SETS

### Set includes:

- Electric-powered trolley.
- High performance accumulator with pulse charging device
- Remote control with battery, charger and belt holder. The remote control can be switched from two-handed to one-handed operation - flexible left/right).
- Adequate transport trolley



Up to 30 metric tons easy to move!



For information on matching  
**CASTORS**  
see pages 64-65.

### JLA-E SETS

TYPE	JLA-E SET 1	JLA-E SET 2	JLA-E SET 3
JLA-e	1 x JLA-e 5/12 G	1 x JLA-e 15/30 G	1 x JLA-e 25/50 H
Transport trolley	1 x JFB 7 K (adjustable height)	1 x JFB 15 G	1 x JFB 25 G (adjustable height)
Load capacity adjustable	kg	2 x 7 500	2 x 12 500
Number of castors adjustable	Pieces	8	12
Height adjustable	mm	180	230
Supporting surface cassette	mm	170 x 170	220 x 120
Cassette dimensions	mm	325 x 200	460 x 330

ORDER NO. ■ 22 005 102-G SET ■ 22 015 102-H SET ■ 22 025 102-H SET

# **MOVING** **POWERFUL.**

**Strong. Easy. Reliable.**



**JUNG**

# TRANSPORT TROLLEYS SERIES G PROFESSIONAL

For loads up to 60 metric tons, height 180 mm

## i DESCRIPTION

■ From JLB 20 up, pivoting cassettes and axles within the frame assure even pressure distribution across all castors and across the floor. No need for complex and expensive hydraulic compensation system.

■ The double castor design results in dramatically easier steering due to reduced friction forces in curves. The much lower friction resistance also causes the trolleys on the rear axis to follow in a true to track course.

■ All transport trolleys are ready for use: The steerable transport trolley is fitted with a ball bearing supported turntable and a handlebar (as shown in picture). The adjustable-width transport trolley consists of two transport units and connecting bar.



Steerable G-series trolley in action

For information on matching  
**ACCESSORIES**  
see Pages 66-67.



Loads up to		30 t		40 t	
TYPE		JLB 15 G	JFB 15 G	JLB 20 G	JFB 20 G
Load capacity	kg	15 000	2 x 7 500	20 000	2 x 10 000
Number of castors	Pieces	12	12	16	16
Castor dimensions	Ø x l mm	140 x 59	140 x 59	140 x 59	140 x 59
Height	mm	180	180	180	180
Supporting surface per cassette	E x F mm		220 x 120		220 x 200
Cassette dimensions	L2 x B2 mm		460 x 205		460 x 285
Connecting bar with joint	Length mm		2 x 1 540		2 x 1 540
Cassettes adjustable from - to	G - H mm		415 - 1 300		475 - 1 300
Supporting surface of turntable	Ø C mm		215		215
Dimensions	L1 x B1 mm		565 x 610		565 x 741
Handlebar with pulling eye	Length mm		1 230		1 230
Weight JUWathan®plus	kg		90		82
ORDER NO. with JUWathan®plus		09 152 140-V	10 152 140-V	09 202 140-V	10 202-140-V

For information on matching  
**CASTORS**  
see pages 64-65.



Loads up to		60 t	
TYPE		JLB 30 G	JFB 30 G
Load capacity	kg	30 000	2 x 15 000
Number of castors	Pieces	24	24
Castor dimensions	Ø x l mm	140 x 59	140 x 59
Height	mm	180	180
Supporting surface per cassette	E x F mm		220 x 200
Cassette dimensions	L2 x B2 mm		460 x 400
Connecting bar with joint	Length mm		2 x 1 540
Cassettes adjustable from - to	G - H mm		530 - 1 300
Supporting surface of turntable	Ø C mm		215
Dimensions	L1 x B1 mm		565 x 995
Handlebar with pulling eye	Length mm		1 480
Weight JUWathan®plus	kg		135
ORDER NO. with JUWathan®plus		09 302 140-V	10 302 140-V2

# TRANSPORT TROLLEYS SERIES H

For loads up to 200 metric tons, height 230 mm/240 mm

## **i** DESCRIPTION

■ Unrivalled: Small and light-weight trolleys at super high capacity.

■ Steerable transport trolleys with pivoting cassettes for a better load distribution at all castors and the floor.

■ All transport trolleys are ready for use: the steerable transport trolley is fitted with a ball bearing supported turntable and a handlebar. The adjustable-width transport trolley consists of two transport units and connecting bars.

■ Also available as Professional version with JUWathan twin castors: the double castor design results in dramatically easier steering due to reduced friction forces in curves. The much lower friction resistance also causes the castors on the rear axis to follow in a true to track course.



Steerable H-series trolley in action



JLB & JFB 60 H with Professional-castors



TYPE	80 t		120 t			
	JLB 40 H	JFB 40 H	JLB 60 H	JFB 60 H		
Load capacity	kg	40 000	2 x 20 000	60 000	2 x 30 000	
Number of castors/twin castors	Pieces	8/16	8/16	8+8/24	8+8/24	
Castors/twin castors dimensions	Ø x l mm	200 x 170/200 x 85	200 x 170/200 x 85	200 x 170/200 x 85	200 x 170/200 x 85	
Height	mm	230	230	230	230	
Supporting surface per cassette	E x F mm		395 x 260		395 x 260	
Cassette dimensions	L2 x B2 mm		740 x 395		740 x 580	
Connecting bar with joint	Length mm		2 x 1 540		2 x 1 540	
Cassettes adjustable from - to	G - H mm		585-1 155		585-1 155	
Supporting surface of turntable	Ø C mm		250		250	
Cassette dimensions	L1 x B1 mm		650 x 1 060		650 x 1 400	
Handlebar with pulling eye	Length mm		1 590		1 590	
Weight JUWathan®	kg		320	289	450	410
<b>ORDER NO. with JUWathan®</b>		<b>09 400 200-H</b>	<b>10 400 200-H</b>	<b>09 600 200-H</b>	<b>10 600 200-H</b>	
<b>ORDER NO. with JUWathan® twin castors</b>		<b>09 400 206-H</b>	<b>10 400 206-H</b>	<b>09 600 206-H</b>	<b>10 600 206-H</b>	

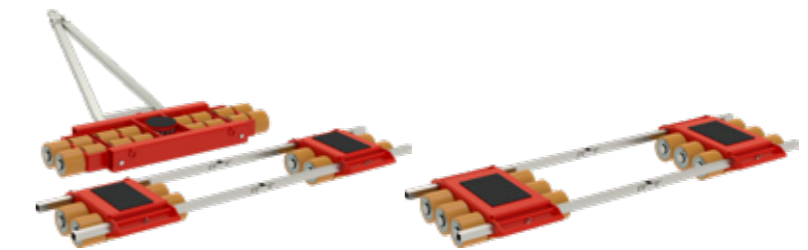

TYPE	160 t		120 t		
	JL 80 H	JFB 80 H	JFB 120 H		
Load capacity	kg	80 000	2 x 40 000	2 x 60 000	
Number of castors/twin castors	Pieces	16/32	16/32	24/48	
Castors/twin castors dimensions	Ø x l mm	200 x 170/200 x 85	200 x 170/200 x 85	200 x 170/200 x 85	
Height	mm	240	240	240	
Supporting surface per cassette	E x F mm		400 x 260	440 x 300	
Cassette dimensions	L2 x B2 mm		750 x 820	960 x 830	
Connecting bar with joint	Length mm		2 x 3 000	2 x 3 000	
Cassettes adjustable from - to	G - H mm		830 - 2 530	830 - 2 530	
Supporting surface of turntable	Ø C mm		250		
Cassette dimensions	L1 x B1 mm		820 x 1 900		
Handlebar with pulling eye	Length mm		1 590		
Weight JUWathan®	kg		723	565	815
<b>ORDER NO. with JUWathan®</b>		<b>09 800 200-H</b>	<b>10 800 200-H</b>	<b>10 912 200-H</b>	
<b>ORDER NO. with JUWathan® twin castor</b>		<b>09 800 206-H</b>	<b>10 800 206-H</b>	<b>10 912 206-H</b>	

# ACCESSORIES FOR FORKLIFTS

## Transport dolly hitch, steering traverse & forklift clamps

### i DESCRIPTION

■ **FORKLIFT HITCH** for pushing and pulling loads. Includes lashing chain to secure to forklift truck. Suitable for all JUNG trolleys outfitted with a towing eye.

■ Simply place on forklift forks, secure with lashing chain and go.

■ Capable of moving loads forward and in reverse.

■ Easy maneuverability.

■ 3 metric tons traction force.



TYPE		■ JRH 3	
Push/Pull force	kg	3 000	
Dimensions L x W x H	L x W x H mm	425 x 590 x 325	
Hitch pin	Ø mm	40	
For forks	max. mm	90 x 170	
Fork separation	min. mm	240	
Weight	kg	37	

ORDER NO. ■ 13 303 000-B

### i DESCRIPTION

■ **Forklift turntable** for maneuvering heavy loads with a forklift truck.

■ Simply place on the forklift forks and go.

■ Usable as steerable support for 3 tons or 15 metric tons.

■ Thrust bearing supported turntable with anti-slip load pad.

■ Reversed side equipped with anti-slip pads.



TYPE		■ JLT 3		■ JLT 15	
Load capacity	kg	3 000		15 000	
Dimensions	L x W x H mm	550 x 240 x 100		550 x 300 x 174	
Supporting surface of turntable	Ø mm	150		250	
For forks	max. mm	180		180	
Fork separation	min. mm	200		200	
Weight	kg	15		41	

ORDER NO. ■ 13 203 000-V ■ 13 215 000-V

### i DESCRIPTION

■ **Set of forklift clamps with tie-down straps** for binding and securing.

■ Simply attach the screw type fork clamps to the forks behind the load.

■ Slide eye type fork clamps onto the tips of the forks and strap load in between for safe transport.

■ Secure valuable and unstable loads against slipping.

■ More safety for movement of top heavy loads.

■ Each set includes 2 screw type fork clamps, 2 eye type fork clamps and 2 tie-down straps.



Secure loads with forklift clamps and tension belts

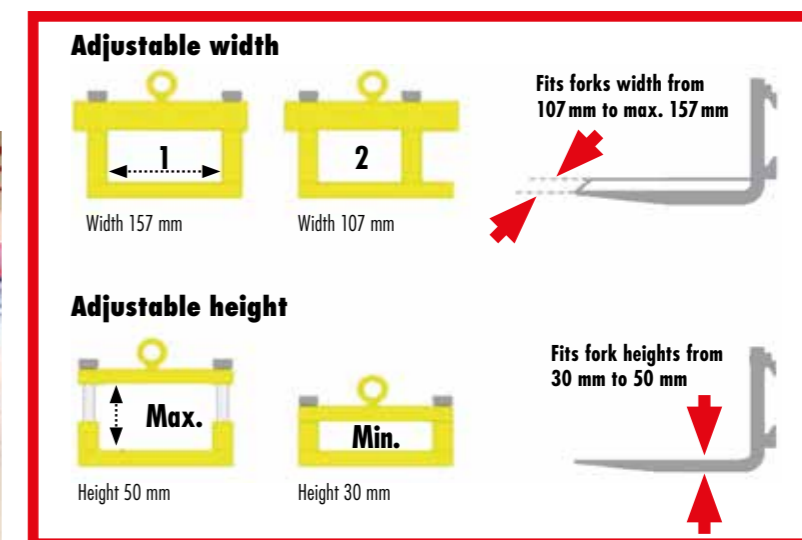

TYPE		■ JGK-A		■ JGK-R	
Version		with SWIVEL eye bolts		with FIXED eye bolts	
Features		turnable		fixed	
Forks width	mm	107 - 157		107 - 157	
Forks height	mm	30 - 50		30 - 50	
Length of tie-down straps	mm	5 000		5 000	
Bind capacity	daN	400		400	
Weight	kg	19		18	

ORDER NO. ■ 25 090 401-B ■ 25 090 451-B



# STURDY CASTORS FOR ANY APPLICATION

## High quality coatings

### DESCRIPTION

■ **JUWathan®** castor design: The coating is molded around a steel core. Two precision ball bearings are pressed into the steel core.

■ **JUWathan® plus** castor design: The basis of the **JUWathan®** castor is a further advanced coating (plus) based on **JUWathan® plus** castor. A coating of a special polyurethane-based compound is applied to an aluminium core. The thickness of the rubber has been optimised to such an extent that the rolling resistance is reduced by more than 30%. A weight saving of almost 35% per castor was also achieved by the new construction.

■ **JUWathan® Professional:** The professional series castor was developed based on the **JUWathan® plus** castor. The side-by-side double castor system provides higher load capacity (2x2 ball bearings) and offers greatly reduced rolling resistance. Turning of the steerable trolley requires less force because the castors can turn against one another resulting in extremely reduced friction between surface and castor. The much lower friction resistance also causes directional stability.



JUWathan® plus		SERIES K	SERIES K PROFESSIONAL	JKB	SERIES G
Load capacity	kg	750	875	375	1 250
Outside diameter	D mm	85	85	85	140
Inside diameter	d mm	25	25	25	35
Fitting length	l mm	85	85	43	59
Weight	kg	0,85	1,05	0,5	1,85

ORDER NO. ■ 95 050 057-V ■ 95 050 089-D ■ 95 050 131-V ■ 95 050 047-V

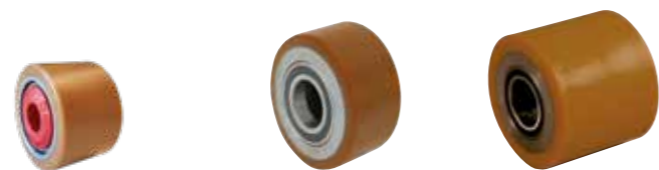

JUWathan®		SERIES S	SERIES H	SERIES H
Load capacity	kg	1 000	2 500	5 000
Outside diameter	D mm	90	200	200
Inside diameter	d mm	25	70	70
Fitting length	l mm	60	83	170
Weight	kg	0,95	9,8	19,2

ORDER NO. ■ 95 050 304-V ■ 95 050 090-D ■ 95 050 053-V

\*We grant 5 years of warranty on operability of our JUWathan®-castors except improper use or normal abrasion.

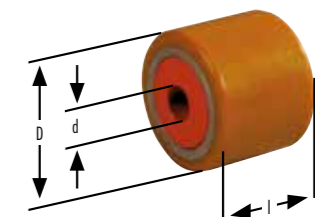

### DESCRIPTION

■ **JUWAmid**-castor design: Two precision ball bearings are pressed into a high quality polyamid coating.

■ **Steel** castor design: The steel body is made of a seamless steel tube. Two precision ball bearings are pressed into the steel core.

### RECOMMENDED USE

Recommended use for	Castor type and coat		
	JUWathan® JUWathan® plus JUWathan® Professional	JUWAmid	Steel
Plain and clean floors	✓	✓	
For any floors, swarf resistant	✓		
Bad floors with roughness			✓



JUWAmid		JKB	JKB R	SERIE K
Load capacity	kg	375	375	750
Outside diameter	D mm	85	85	85
Inside diameter	d mm	25	25	25
Fitting length	l mm	43	43	85
Weight	kg	0,35	0,35	0,55

ORDER NO. ■ 95 050 088-P ■ 95 050 091-P ■ 95 050 023-P



STEEL		SERIE K	SERIE S
Load capacity	kg	750	1 000
Outside diameter	D mm	85	90
Inside diameter	d mm	25	25
Fitting length	l mm	85	60
Weight	kg	2,45	1,4

ORDER NO. ■ 95 050 043-S ■ 95 050 305-S

# USEFUL ACCESSORIES

## For transport trolleys

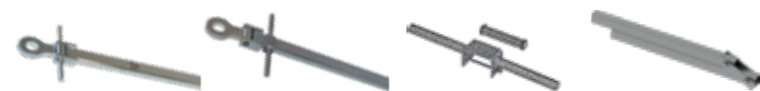

TRANSPORT TROLLEYS SERIES K		STEERING ROD WITH EYE	TOWING BAR COMPLETE WITH REMOVABLE HANDLE	REMOVABLE HANDLE	EXTENDED CONNECTING BAR
		JLB 3 K	JLB 6 K - JL 14 K	JLB 6 K - JL 14 K	JFB 6 K - JFB 14 K
Dimensions	mm	1 120 length	1 210 length	330 x 45 x 40	2 360 length
Catalogue page		28	28-31	28-31	28-31
<b>ORDER NO.</b>		<b>92 010 148-B</b>	<b>92 010 122-B</b>	<b>92 090 300-B</b>	<b>92 010 063-B</b>



REVOLVING TRANSPORT TROLLEYS JKB 1,5 K - JKB 7,5 K		PULLING HANDLE	CONNECTING BAR
		JKB 1,5 K - JKB 7,5 K	JKB 1,5 K - JKB 3 K JKB 4 K - JKB 7,5 K
Dimensions	mm	990 length	1 200 length 2 400 length (2 x 1 200)
Catalogue page		34-36	34 34-36
<b>ORDER NO.</b>		<b>92 030 085-L</b>	<b>92 030 085-V</b> <b>92 040 085-V</b>



REVOLVING TRANSPORT TROLLEYS JKB 10 G - JKB 14 G		PULLING HANDLE	CONNECTING BAR
		JKB 10 G - JKB 14 G	JKB 10 G - JKB 14 G
Dimensions	mm	1 450 length	2 000 length (on request up to 3 000 length)
Catalogue page		37	37
<b>ORDER NO.</b>		<b>92 226 042-B</b>	<b>92 100 140-V</b>



MULTI-PURPOSE TROLLEYS SERIE M		PULLING HANDLE	CONNECTING BAR
		JLF 3,5 - JLF 5	JLF 3,5 - JLF 5
Dimensions	mm	1 210 length	1 200 length
Catalogue page		38-39	38-39
<b>ORDER NO.</b>		<b>92 010 022-B</b>	<b>92 030 085-V</b>



TANDEM TROLLEYS		EXTENDED CONNECTING BAR		
		JTLB 6 K	JTLB 14 K	JTL 20 G & JTLB 30 G
Dimensions	mm	Length on request	Length on request	Length on request
Catalogue page		42	42	43
<b>ORDER NO.</b>		<b>92 010 160-B</b>	<b>92 010 161-B</b>	<b>92 010 163-B</b>



ELECTRIC-POWERED TRANSPORT TROLLEYS		QUICK-CHARGER	EXTENSION BATTERY CABLE SET		DRIVE WHEEL
		JLA-e 5/12 G JLA-e 15/30 G JLA-e 25/50 H	JLA-e 5/12 G JLA-e 15/30 G JLA-e 25/50 H	JLA-e 5/12 G JLA-e 15/30 G JLA-e 25/50 H	JLA-e 5/12 G JLA-e 15/30 G JLA-e 25/50 H
Dimensions	mm	-	5 000	10 000	140 x 118 x 35 200 x 83 x 70
Catalogue page		52-53	52-53	52-53	52 53
<b>ORDER NO.</b>		<b>23 050 556-E</b>	<b>93 151 003-B5</b>	<b>93 151 003-B10</b>	<b>93 050 157-V</b> <b>93 050 521-V</b>



TRANSPORT TROLLEYS SERIES G		EXTENDED CONNECTING BAR
		JFB 15 G - JFB 30 G
Dimensions	mm	3 000 length (two-piece)
Catalogue page		58-59
<b>ORDER NO.</b>		<b>92 090 060-B</b>



TRANSPORT BOXES		TOOL BOX	TRANSPORT BOX JLA-E	
		On request	JLA-e 5/12 G	JLA-e 15/30 G JLA-e 25/50 H
Dimensions	mm	1 200 x 800 x 500	1 000 x 900 x 820	1 300 x 1 000 x 820 1 940 x 1 268 x 600
Catalogue page		-	52	52 53
<b>ORDER NO.</b>		<b>92 120 800-TK</b>	<b>93 100 800-H</b>	<b>93 120 800-H</b> <b>93 200 125-H</b>

# QUICKLY TRANSPORTED.

# JUNG

## HYDRO-TRANSPORTER



For loads up to 3,8 metric tons

### **i** DESCRIPTION

■ Hydro-Transporter are ideal for moving cabinets, safes, boxes or machines. They are easy and safe in use. One transporter consists of 2 transport units and two belts to connect. The transport units are attached on the sides of the load and connected with the standard belt.

■ After pumping up the movable part of the transporter on both sides the load is lifted and ready for moving.

■ Both transport units are easy to transport together.

■ Steering can be done by the top link bars on each unit, connected with the big wheels equipped with ball bearings. The linkage guarantees that the wheels are always in parallel direction.

■ Scope of delivery: 2 transport units, 2 connecting belts (5m)

■ High lifting height: 180 mm



Boxes, safes or machines - quick and easy to handle with the Hydro-Transporter!



Loads up to		1,8 t	3 t	3,8 t
TYPE		JHT 18 S	JHT 30 S	JHT 38 S
Load capacity	kg	1 800	3 000	3 800
Stroke	mm	180	180	180
Height	H mm	1 010	1 080	1 080
Length	B mm	540	585	640
Belt length	mm	5 000	5 000	5 000
Wheel diam. Ø	mm	150	200	200
Weight	kg	82	103	107
ORDER NO.		30 181 002-H	30 301 001-H	30 351 002-H

# GALVANIZED STEEL EQUIPMENT & CUSTOMISED SOLUTIONS

## GALVANIZED STEEL EQUIPMENT

- Better surface protection in case of collision damage (no chipping of the topcoat).
- Improved protection against corrosion.
- Good application in sensitive environments such as clean rooms.
- Surface protection, solvent resistance.



**JH 6 G plus galvanized**

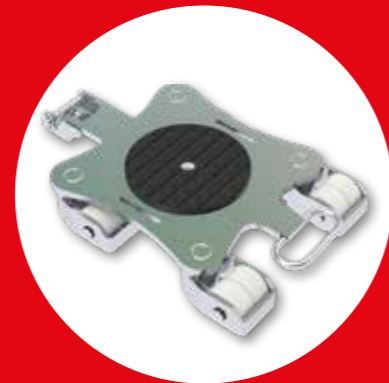

**JKB 3 galvanized**

## CUSTOMISED SOLUTIONS



**Towing devices**



**Special types of lifting toes/Special adapter for jacks**

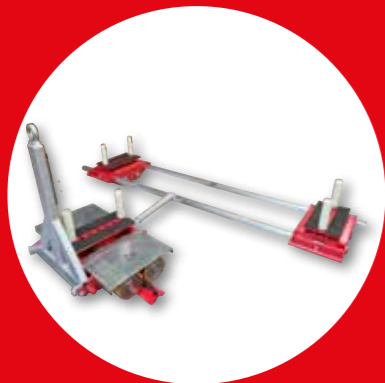

**Customised transport set  
JLB & JFB 40 H**



**Trolley with stroke for loads up  
to 30 metric tons**

# CATALOG OVERVIEW

Visit us on:   



**Tugger trains for  
intralogistics**

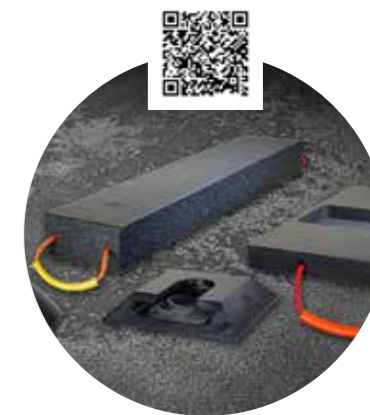

**Support technology/  
Ground protection**



**Industrial hydraulics  
BVA**



**Leveling castors**



**Lifting bags**

### Custom solution needed?

We solve uncommon lifting and transport problems by custom solutions - safe, fast and cost effective. Please do not hesitate to contact us!

**Design, manufacturing, consulting, sales and service:**

**JUNG Hebe- und Transporttechnik GmbH**

Biegelwiesenstraße 5-7  
F +49 (0)7151 30393-0  
info@jung-hebetechnik.de  
Biegelwiesenstraße 5-7  
D-71334 Waiblingen  
**jung-hebetechnik.de**

Unser Logo und der Name JUNG sind in der EU, in den USA und in China unter folgenden Nummern geschützt:

EU: Logo Nr. 005878897, Name Nr. 005878806

USA: Logo Reg. Nr. 3,713,850, Name Reg. Nr. 3,697,526

China: Logo Nr. 14081450A, Name Nr. 14081449A

Technische Änderungen, die der Verbesserung von Funktion und Qualität dienen, behalten wir uns vor.

Made in Germany 07.2022 · Printed in Germany

Our logo and brand name „JUNG“ are registered as trademarks in the EU, US and China with register numbers:

EU: logo no. 005878897, name no. 005878806,

USA: logo reg. no. 3,713,850, name reg. no. 3,697,526

China: logo no. 14081450A, name no. 14081449A

We reserve the right to make technical modifications which serve to improve function and quality.

Made in Germany 07.2022 · Printed in Germany

**JUNG**  
**JUNG-HEBETECHNIK.DE**